

# OEU-202S-HMK2 Villa Door Station

## Overview

OEU-202S-HMK2 villa door station is one of the terminal equipment of the digital building intercom system, with functions of video intercom, security alarm, video surveillance, etc., providing a safe and comfortable living environment for residents. It can be widely used in villa building system.



## Features

- Optional recess box for recess mount.
- Supports power output, which can be enabled or disabled on the Web interface.
- Allows to insert a TF card to expand the storage capacity.
- Built-in heating module supports operation at a very low temperature.
- Metal casing.
- Supports batch configuration.
- Supports call and intercom with the connected indoor stations and apps.
- Supports video monitoring, security alarm, and tamper alarm.
- Built-in IC card reader.

## Ordering Information

Model	Remarks
OEU-202S-HMK2	Villa Door Station

## Specifications

Parameter	Description
Power supply	DC12V $\pm$ 25%, IEEE802.3af PoE power supply

Card capacity	10000
Operating system	Linux
Illuminator	IR light (adaptive)
WDR	Support
FOV	Horizontal: 106.9° Vertical: 56.9° Diagonal: 127.9°
Power consumption	PoE: 6.48W DC12V: 5.35W
Volume adjustment	Support
Audio quality	Noise suppression, echo cancellation, AGC
Audio input	1 x Built-in omnidirectional microphone
Audio output	1 x Built-in speaker
Audio compression format	PCM, G711, MP3
Audio compression bit rate	128Kbps
Protocol	Private protocol
Protection level	IP65 (Apply waterproof glue to the gap between the device and the wall. See the corresponding quick guide for details) IK08
Button	2 x Call button
Weight	675g
Maximum connected indoor station	20
Mount method	Wall mount
Interface	Power*1, network port*1, RS485*1, Wiegand*1, IO input*4, door lock*2 (support electric lock/door magnet), tamper button*1
Network	100Mbps network port, supports IEEE802.3af PoE power supply
Dimensions (LxHxW)	96mm*176mm*33mm
Operating environment	-40°C to 60°C, 10% to 90%, noncondensing, outdoor

## Dimensions

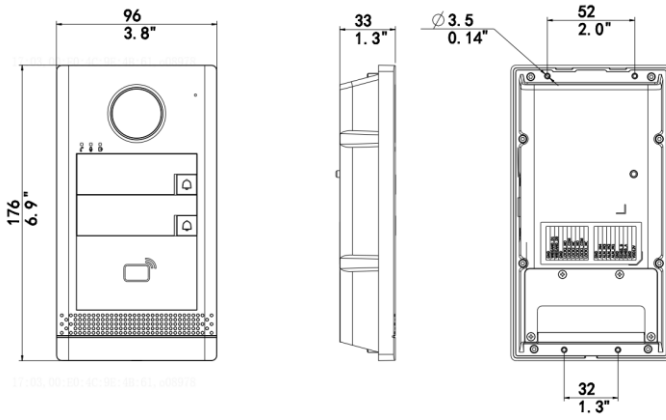

**Zhejiang Uniview Technologies Co., Ltd.**

Xietong Street No. 369, Binjiang District, Hangzhou, China (310051)

Email: [overseasbusiness@uniview.com](mailto:overseasbusiness@uniview.com); [globalsupport@uniview.com](mailto:globalsupport@uniview.com)

<http://www.uniview.com>

©2024 Zhejiang Uniview Technologies Co., Ltd. All rights reserved.

\* Product specifications and availability are subject to change without notice.